

Tekna Evo

SOLENOID DOSING METERING PUMPS



innovation > technology > future

The **Evo...lution** of solenoid dosing pumps

A new concept of programming menu. Once a function is selected, the pump displays only the parameters that are associated with the specific function

PVDF pump head and ceramic ball valve as standard

Stabilized Multi Power Supply 100÷240 Vac 50/60 Hz with reduced consumption



Compatible

PVDF pump head and ceramic ball valve as standard

- **PVDF** is suitable for almost all chemical used in the Industrial, Waste Water Treatment and potable Water applications
- The use of **Ceramic balls** as standard improves the pumping reliability and the chemical compatibility of the whole liquid end
- **evo Full chemical compatibility**



Reliable

Long life diaphragm tested to give 5 years working life

- The advanced design and manufacturing process allows the diaphragm to have a unique life expectancy
- Made of pure solid **PTFE**, the diaphragm is compatible with most chemicals
- The diaphragm has been tested over a period of 5 years giving superior results
- Routine diaphragm replacement is no longer a requirement
- **evo Reduced maintenance Full chemical compatibility**



Clever

Just 5 Models, Just PVDF,
All functions in one pump

○ **5 models** that cover 0,4 to 54 l/h with an output pressure up to 20 Bar

○ **1 Casing** allows skids to be pre-constructed, as the fixing points remain constant, and the pumps can be selected on confirmation of the dosing flow

evo **Inventory Reduction**
Reduce spares stock holding



Steady Dosing Performance

Stabilized Multi Power Supply 100÷240 Vac 50/60 Hz with reduced consumption

● Reduced power consumption as the solenoid only draws the required power to activate the pump, based on the working conditions

evo **Stable dosing performance:** improve pump efficiency as performance is not affected by power supply fluctuations
Reduce inventory holding



Intuitive programming

A new concept of programming menu

● Programming menu are self explanatory and available in 5 languages

● **Intelligent Display**, once a function is selected the pump will only display the parameters to set, which are linked to the selected function

evo **Reduced programming time**

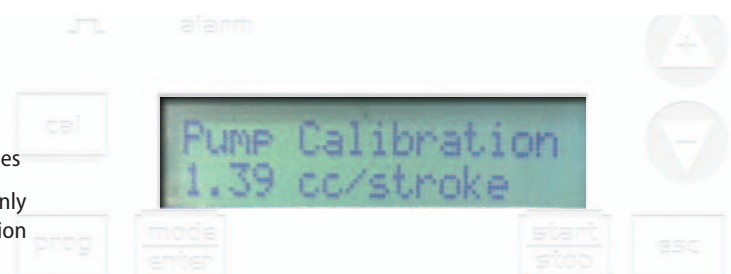

Analogue Version

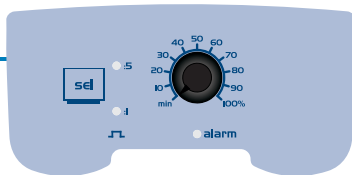

AKL Costant dosage

Analogue dosing pump with constant flow rate manually adjustable by control dial on the front panel, two frequency range (0÷20% or 0÷100%), Power-ON led indicator and level control input.

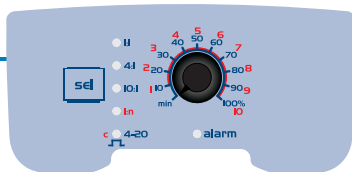

APG Proportional dosage

Analogue dosing pump with constant flow rate manually adjustable, proportional flow rate according to an external analogue (4÷20 mA) or digital pulse signal (e.g. from water meter).

- Control dial (percentage and "n" value in multiplication mode)
- 6 position adjustable switch:
 - 3 in division mode (1, 4, 10 = n)
 - 1 in multiplication mode (n=1)
 - 1 for proportional 4÷20 mA signal
 - 1 for constant functionality
- "pacing" function adjustable by dip switch

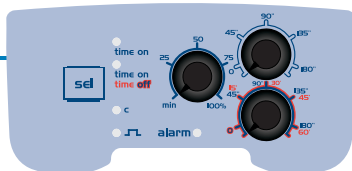

ATL Timed dosage

Analogue dosing pump with constant flow rate manually adjustable and timed dosage with T on-T off double regulation.

- 3 control dials (flow rate percentage - T on regulation - T off regulation)

Digital Version

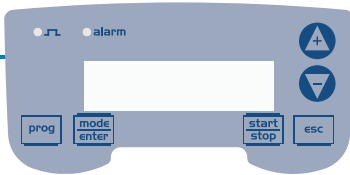

TPG Proportional dosage

Digital dosing pump with constant flow rate manually adjustable, proportional flow rate according to an external analog (4÷20 mA) or digital pulse signal (e.g. from water meter).

- Timer function, ppm dosing, statistics, password and On/Off input (remote switch).

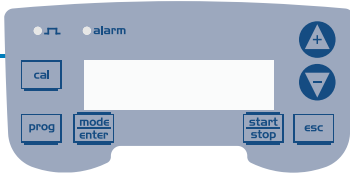

TPR Proportional dosage

Digital dosing pump with pH/Redox control meter built in.

- Digital interface for constant or proportional dosing, depending on the measured pH or Rx value
- PT100 probe input for thermal compensation
- Repetition alarm relay
- Input On-Off for remote control
- 4÷20 mA output for measure transmission

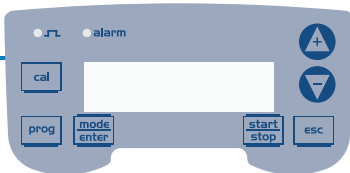

TMP Proportional dosage

Digital dosing pump with Chlorine, Hydrogen Peroxide or Per-Acetic Acid control meter built in.

- Instrument on board set via Software
- PT100 probe input for thermal compensation
- Repetition alarm relay
- Input On-Off for remote control
- 4÷20 mA output for measure transmission

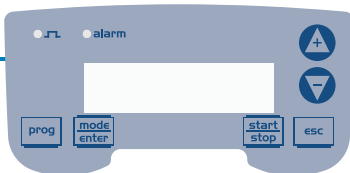

TCK Timed dosage

Digital dosing pump with constant flow rate manually adjustable, or timer control.

- Programmable timed relay

Pumps Identification

Version		
AKL	Analogue	Analogue dosing pump with constant flow rate manually adjustable
APG		Analogue dosing pump with constant flow rate manually adjustable, with proportional flow rate according to an external analog (4÷20 mA) or digital signal (water meter)
ATL		Analogue dosing pump with constant flow rate manually adjustable and timed dosage with T on-T off double regulation
TPG	Digital	Digital dosing pump with constant flow rate manually adjustable, with proportional flow rate according to an external analog (4÷20 mA) or digital signal (water meter)
TPR		Digital dosing pump with pH/Redox control meter built in
TMP		Digital dosing pump with Chlorine, Hydrogen Peroxide or Per-Acetic Acid control meter built in
TCK		Digital dosing pump with constant flow rate or timed

Model	Pressure [bar]	Flow rate [L/h]	Stroke capacity [cc/stroke]	Ø Connections IN / OUT [mm]	Frequency max [stroke/min]	Consumption [WW]
500	20	0,4	0,06	4 / 7	120	12,2
	16	0,8	0,11			
	10	1,2	0,16			
	6	1,5	0,21			
600	20	2,5	0,35	4 / 6 suc. 4 / 7 dis.	120	12,0
	18	3	0,42			
	14	4,2	0,58			
	8	3	0,97			
603	12	4	0,42	4 / 6	160	12,2
	10	5	0,52			
	8	6	0,63			
	2	8	0,83			
800	16	7	0,38	4 / 6	300	23,9
	10	10	0,55			
	5	15	0,83			
	1	18	1,00			
803	5	20	1,11	8 / 12	300	22,9
	4	25	1,39			
	2	40	2,22			
	0,1	54	3,00			

Power supply

N	100 ÷ 240 Vac	50-60 Hz
O	24 ÷ 48 Vac (For AKL 603 series only. For APG 603 : 30-48Vac/Vdc)	

Liquid end material

H	Pump head : PVDF	Balls : Ceramic	Diaphragm : PTFE
----------	------------------	-----------------	------------------

Installation Kit

H	PVDF
----------	------

Seals

0	FPM
1	EPDM

Options

000	Standard
------------	----------

AKL | **600** | **N** | **H** | **H** | **O** | **000**

Flow Rate and Dimensional Drawings

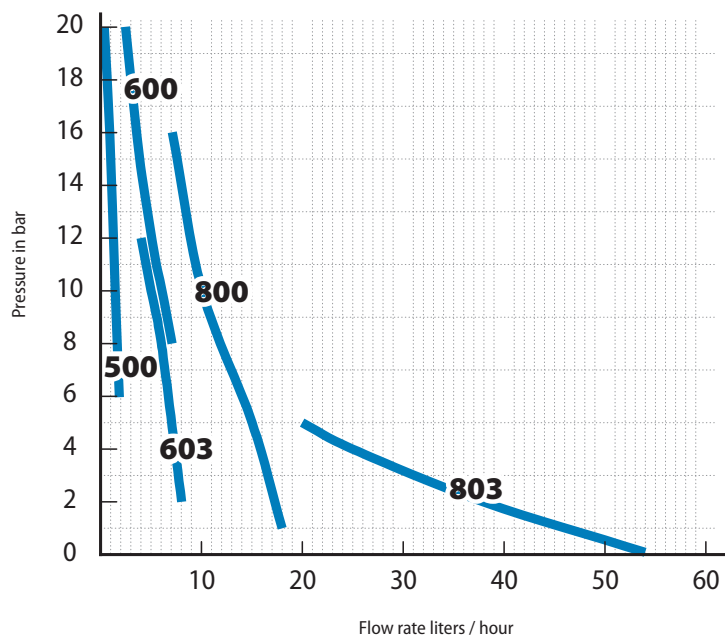

PERFORMANCE CURVE

Model	Pressure	Flow rate
500	20 ÷ 6 bar	0,4 ÷ 1,5 l/h
600	20 ÷ 8 bar	2,5 ÷ 3,0 l/h
603	12 ÷ 2 bar	4 ÷ 8,0 l/h
800	16 ÷ 1 bar	7 ÷ 18 l/h
803	5 ÷ 0,1 bar	25 ÷ 54 l/h

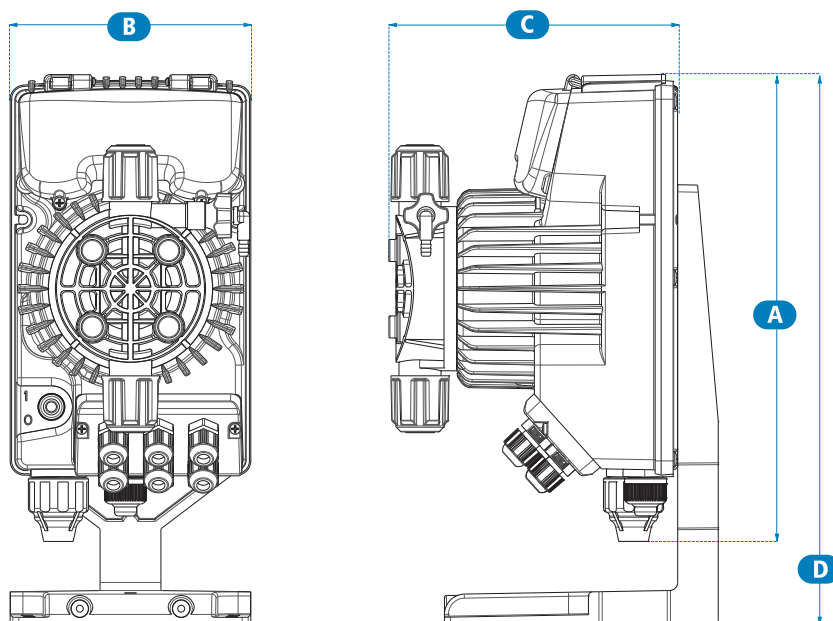

DIMENSIONS [mm]

Model	500 600 603 800	803
A (Height)	231	
B (Width)	119	
C (Depth)	145	149
D (Max Height)	257	

Typical Installation

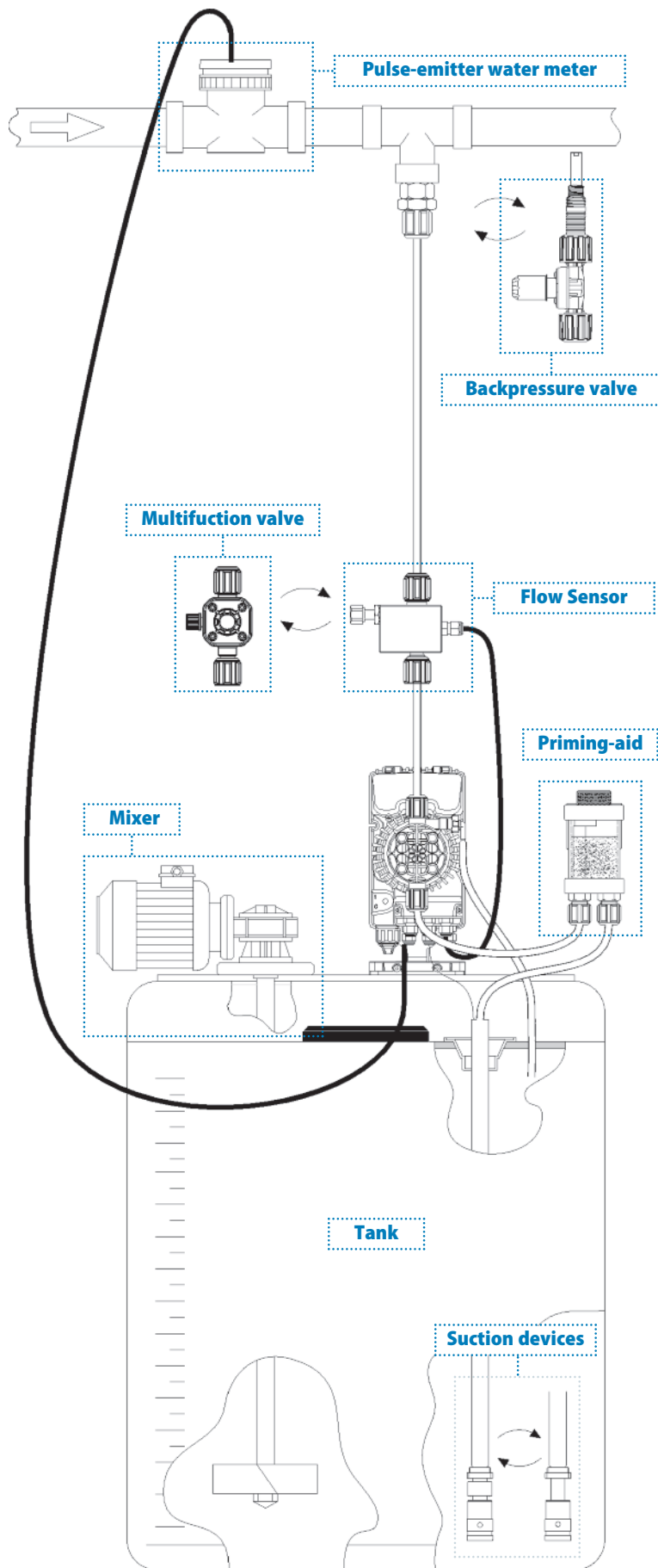

Degassing head installation

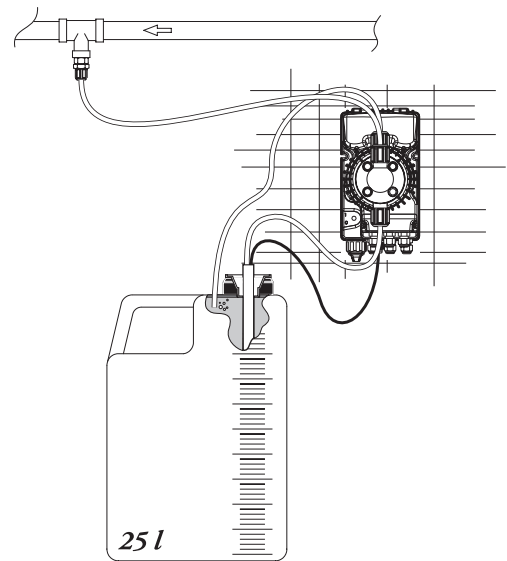

With control instrument

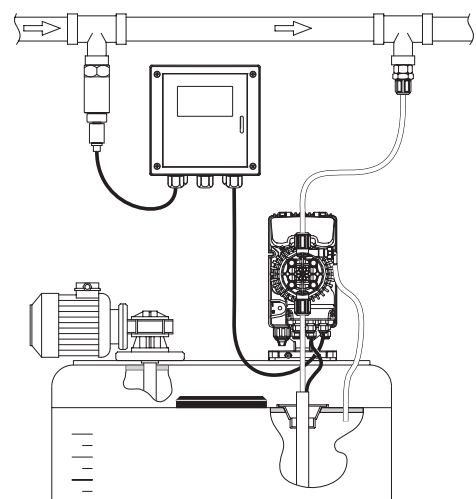

Accessories Pulse-emitter water meters

The meters which we offer have high precision and sensitivity according to CEE standard requirements. Their plastic and metallic parts, in particular those in contact with water, comply with current regulations and are subject to extensive checks and controls.



■ **Threaded** water meters



■ **Flanged** water meters

Threaded water meters

TC1 Series	TH1 Series	TC0 Series
<ul style="list-style-type: none"> Single-jet water meters with pulse sender Dry dial Roller reading 4 or 1 pulse/l Cold water up to 30 °C Connections: from ½"(13 mm) to 2" (50 mm) 	<ul style="list-style-type: none"> Single-jet water meters with pulse sender Dry dial Roller reading 4 or 1 pulse/l Hot water up to 90 °C Connections: from ½"(13 mm) to 2" (50 mm) 	<ul style="list-style-type: none"> Single-jet water meters without pulse sender Dry or wet dial Roller reading Cold water up to 30 °C Connections: from ½"(13 mm) to 2" (50 mm)

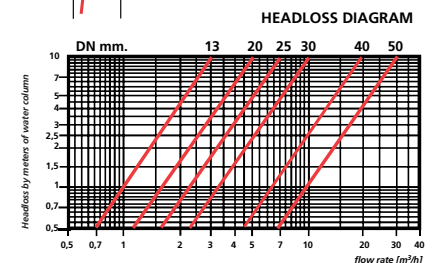
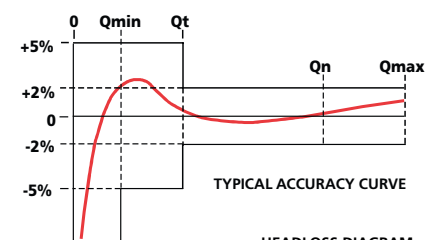

Flanged water meters

FC Series

- A high capacity helical vane (Woltmann) type water meter
- Dry dial reading
- Pulse sender
- Cold water up to 50°C
- Connections: from 2"(DN50) to 6" (DN 150)

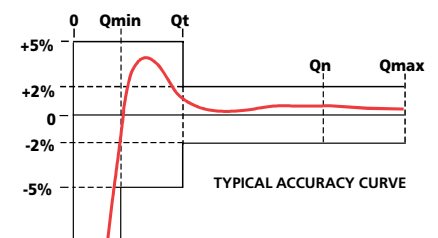

Size	mm	DN	13	20	25	30	40	50	50	65	80	100	140
	Inch		½	¾	1	1 ¼	1 ½	2	2	2 ½	3	4	6
Max flow (short period)	Qmax	m³/h	3	5	7	10	20	30	30	50	80	120	300
Nominal flow	Qn	m³/h	1,5	2,5	3,5	5	10	15	15	25	40	60	150
Min flow (accuracy ±5%)	Qmin	l/h	30	50	70	100	200	450	-	-	-	-	-
		m³/h	-	-	-	-	-	-	0,55	0,6	0,7	1,2	3
Transition flow (accuracy ±2%)	Qt	l/h	120	200	280	400	800	3000	-	-	-	-	-
		m³/h	-	-	-	-	-	-	-	2	4	4	6
Maximum reading		m³	10000	10000	100000	100000	100000	100000	10000	10000	100000	100000	100.000
Starting flow		m³	-	-	-	-	-	-	0,2	0,25	0,25	0,3	1,7
Weight		kg	-	-	-	-	-	-	12,5	13	15,5	19,5	40

Accessories Tanks, Mixers and Suction devices



■ Tanks



■ Uncovered Tanks



■ Reinforcement



■ Fast Mixers (1400 rpm)



■ Suction device without level probe



■ Suction device with level probe

Tanks in polyethylene

Our tanks are designed to assemble dosing systems with mixers and motor driven pumps or solenoid dosing pumps. All are made from food-safe polyethylene, resistant to almost all chemicals normally encountered.

Features			
Model	Capacity (l)	Height (cm)	Diameter (cm)
SER 50	50	45,5	40
SER 100	100	64	46
SER 250	250	87	59,5
SER 300	300	95	67
SER 500	500	118,5	76
SER 1000	1000	122	108,5

Reinforcement

Tank reinforcement made of PVC (20 mm thick) to be used to install mixers and motor driven pumps or solenoid dosing pumps on tanks SER series.

Features	
Model	Tank
SML 100	SER 100
SML 250	SER 250
SML 300	SER 300
SML 500	SER 500
SML 1000	SER 1000

Uncovered Tanks in Polyethylene

Designed to contain our tanks SER series.

Features			
Model	Height (cm)	Diameter (cm)	Tank Model
T150	75,5	51	SER 100
T300	87,5	67	SER 250
T400	99	72	SER 300
T800	120	90	SER 500
T1500	134	122	SER 1000

Mixers

Electric mixers **three-phases** or **single-phase**, **slow (200 rpm)** or **fast (1400 rpm)** and flange attachment, for tanks SER series.

Features					
Shaft (mm)	Propeller (mm)		Motor (kw)	Material	Tank Model
	Fast (1400 rpm)	Slow (200 rpm)			
600	50	150	0,12	PVC SS 316	SER 100
800					SER 250
900		220			SER 300
1100	SER 500/1000				

Suction Devices

A suction filter is provided to protect pump valves from debris or particles that could obstruct the pump valve. Suction devices can also be supplied with integral level controls. These allow the use of alarms, and protect against the system running dry.

Features			
■ Easy to install	■ All suction devices are provided with a foot filter		
■ Standard FPM seals (EPDM upon request)	■ All suction devices are provided with a non return valve		
■ Made of PCV with clear PVC suction tubing			
Dimensions (mm) Length x Ø	4/6 tube	8/12 tube	Tank Model
450 x 22	●		SER 50
450 x 34		●	
650 x 22	●		SER 100
650 x 34		●	
900 x 22	●		SER 250
900 x 34		●	
1050 x 22	●		SER 300
1050 x 34		●	
1250 x 22	●		SER 500/1000
1250 x 34		●	

Accessories Valves, Sensors and Priming-aid



■ **HYC** backpressure valves

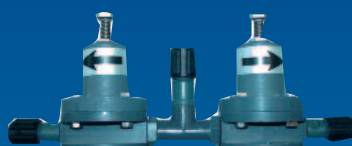

■ **HYM** Multi valve

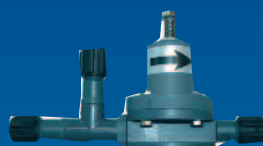

■ **HYS** Safety valves



■ **Injection** valves



■ **Flow Sensor**



■ **Fixed / Adjustable** backpressure valves



■ **Priming-aid**



■ **Multifunction** valve



■ **Pump Head with automatic degassing valve**

HY Series adjustables valves

Features	
Body	PVC
Diaphragm	FPM (standard) or EPDM (upon request)
Connections	1/2" Gm, 4/6 and 8/12 tube
Flow rate	max. 50 l/h
Pressure	max. 10 bar
Temperature	max. 40 °C

Injection valves

Features	
Body	PVC
Seals	FPM (standard) or EPDM (upon request)
Connections	IN 1/2" Gm, 4/6 and 8/12 tube OUT 1/2" Gm
Flow rate	max. 50 l/h
Pressure	max. 10 bar
Temperature	max. 40 °C

Flow Sensor

In order to assess the actual dosing phase, the flow sensor can be used to detect the pump's pulsations during the delivery phase: the sensor can also be used to determine the actual dosing flow rate. This flow sensor is fitted directly on the delivery valve on the dosing pump.

Features	
Body	PVC
Seals	FPM
Pressure	max. 10 bar
Temperature	max. 40 °C

Fixed / Adjustable backpressure valves

The accuracy of the solenoid pumps can be affected by the variation of delivery pressure, especially between 0 and 1 bar. Using the backpressure valve you can guarantee a constant dosing and avoid siphoning cases when metering in the tank. Moreover, dosing with a backpressure avoids to create siphoning phenomena of the pump.

Features	
Body	PVC - PVDF
Diaphragm / Seals	FPM - EPDM
Connections	IN 4/6 tube OUT 3/8" G - 1/2" G
Backpressure	Fixed 1,5 bar Adjustable 0,5 ÷ 5 bar
Temperature	max. 40 °C

Priming-aid

Priming problems may occur on dosing pumps with a low flow rate, and also in case of excessive suction heights in relation to the pump's capacity. This accessory is able to resolve these problems. Where possible it is fitted at the same height as the pump's intake valve and a short distance from it.

Features	
Body	PVC
Seals	FPM
Connections	4/6 tube 8/12 tube
Model	300 ml
Temperature	max. 40 °C

Multifunction valve

Multifunction valve acts as: a backpressure valve, an anti-siphoning valve, a overpressure valve, a priming valve, a delivery drain valve (for maintenance). Multifunction valve is fitted directly on the delivery valve on the dosing pump.

Features	
Body	PVC - PVDF
Diaphragm	PTFE
Connections	4/6 tube
Backpressure	1,5 bar
Overpressure	6 bar 12 bar
Temperature	max. 40 °C

Pump head with automatic degassing valve

It allows to resume the right dosing without any intervention from the user, in case you meter some products generating gases.

Features	
Body	PVC
Seals	FPM
Balls	Ceramic
Connections	4/6 tube
Flow rate reduction	max. 20%
Temperature	max. 40 °C

Bear in mind: to be exclusively used combined with 603 and 800 series pumps.

A Worldwide Group at your service

seko is an International Group, developing, manufacturing and delivering its products in more than 50 countries, through its subsidiaries and an extended network of distributors, agents and authorized dealers.

seko is a leading manufacturer of dosing pumps and dosing systems with more than 40 years experience. This long activity allowed **seko** to acquire a vast experience in diversified applications and to confirm its international success in many industrial fields through the supply of reliable solutions for the dosing, injection and transfer of liquids.



BRAZIL

■ **Seko do Brasil Comercio de Sistemas de Dosagem Limitada**
03170-050 São Paulo (SP)
sekobrasil@sekobrasil.com.br
www.sekobrasil.com.br

BENELUX

■ **Seko Benelux B.V.**
7532 SK Enschede
(The Netherlands)
info@sekobenelux.com

CHINA

■ **Seko China Ltd**
072750 Hebei
china@seko.com
www.sekochina.com

DENMARK

■ **Seko Denmark**
DK-4930 Maribo
info@seko.com

FRANCE

■ **Seko Lefranc-Bosi S.A.**
77435 - Marne La Vallée
Cedex 2
lefrancbosi@lefrancbosi.com
service.commercial@seko.fr
www.lefrancbosi.com

GERMANY

■ **Seko Deutschland GmbH**
55252 Mainz - Kastel
info@seko-messtechnik.de
www.seko-germany.com

ITALY

■ **Seko Spa**
02010 S.Rufina - Rieti
sales@seko.com

ITALY

■ **Seko Spa [Process & Sytems]**
20068 Peschiera Borromeo - Milano
info.psd@seko.com
info@seko.com

ROMANIA

■ **Seko Sieta S.r.l.**
400393 Cluj-Napoca
info.dpro@seko.com

RUSSIA

■ **OOO Seko**
129347 - Moscow
sekorussia@seko.com
www.sekorussia.ru

SINGAPORE

■ **Seko Dosing Systems Asia Pacific Pte Ltd**
608838 Singapore
asiapacific@seko.com

SOUTH AFRICA

■ **Seko Southern Africa (PTY) Ltd**
Kyasand - Johannesburg - Gauteng
sales@sekosa.co.za

SPAIN

■ **Seko Ibérica Sistemas de Dosificación S.A.**
08960 Sant Just Desvern - Barcelona
sekoiberica@sekoiberica.com

SWEDEN

■ **Seko Sweden**
26123 Landskrona
info@seko.com

TURKEY

■ **Seko Endüstriyel Pompalar ve Proses Sistemleri San. ve Tic. Ltd. Şti.**
Kartal Istanbul
info@seko.com.tr
www.seko.com.tr

UNITED ARAB EMIRATES

■ **Seko Middle East FZE**
P.O. Box 42090 - Hamriyah Free Zone, Sharjah
info@seko.ae
sales@seko.ae

UNITED KINGDOM

■ **Seko UK Chemical Controls Ltd**
Harlow, Essex - CM19 5JH
seko.uk@seko.com
www.sekouk.com

USA

■ **Seko Dosing Systems Corporation**
Tullytown - PA 19007
sales@sekousa.com
www.sekousa.com

For more information
www.seko.com

